

SLIDINGROBES DIRECT

SLIDING WARDROBES DELIVERED TO YOUR DOOR

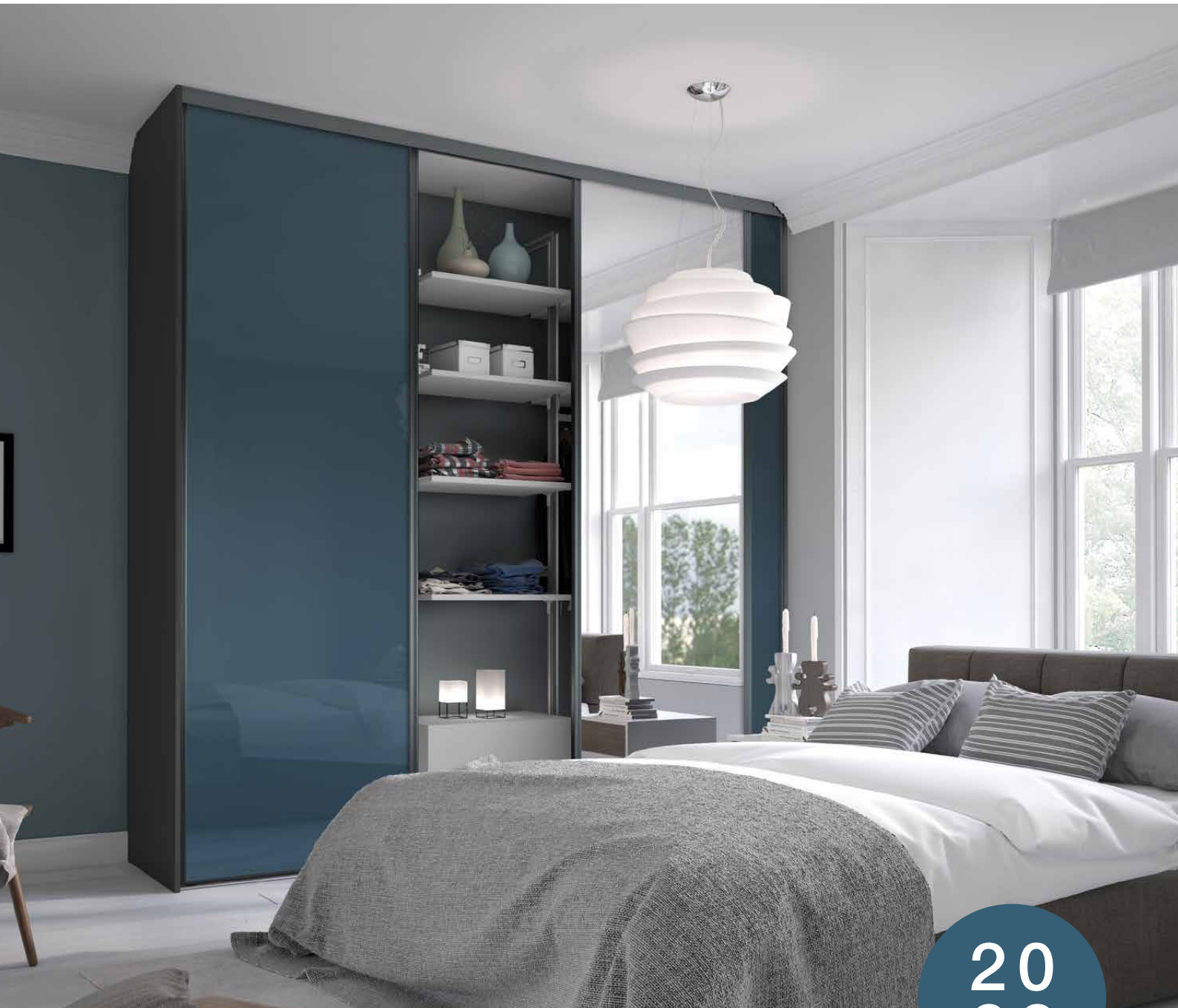

20
22

SLIDING WARDROBES & STORAGE SOLUTIONS

MADE FOR ANY SPACE



CUSTOM DOORS CAN BE MADE AS SMALL AS 1.15M HIGH - PERFECT FOR LOFT SPACES!

Shown here: Shaker 4x Single Panel doors. Mirror with a Cashmere frame and Alutec Interior

FITTED WARDROBES, MADE FOR ANY SPACE

Sliding doors and storage solutions bring unparalleled style to a room, creating wardrobes with clever, functional storage to maximise any space in the home.

CONTENTS

- 04** Why choose sliding doors & modular storage?
- 10** Heritage doors
- 14** Classic doors
- 18** Shaker doors
- 22** Mirage doors
- 26** Glam doors
- 30** Reflex doors
- 34** Switch doors
- 40** Aura storage solutions
- 42** Alutec storage solutions
- 44** Standard storage systems
- 46** Freestanding furniture
- 48** Creating your wardrobe space
- 50** Plan your space for sliding doors
- 52** Plan your space for storage
- 54** Product specifications

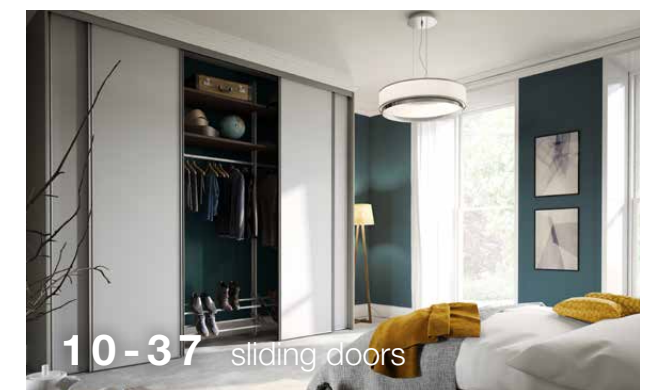

10-37 sliding doors



38-47 storage systems

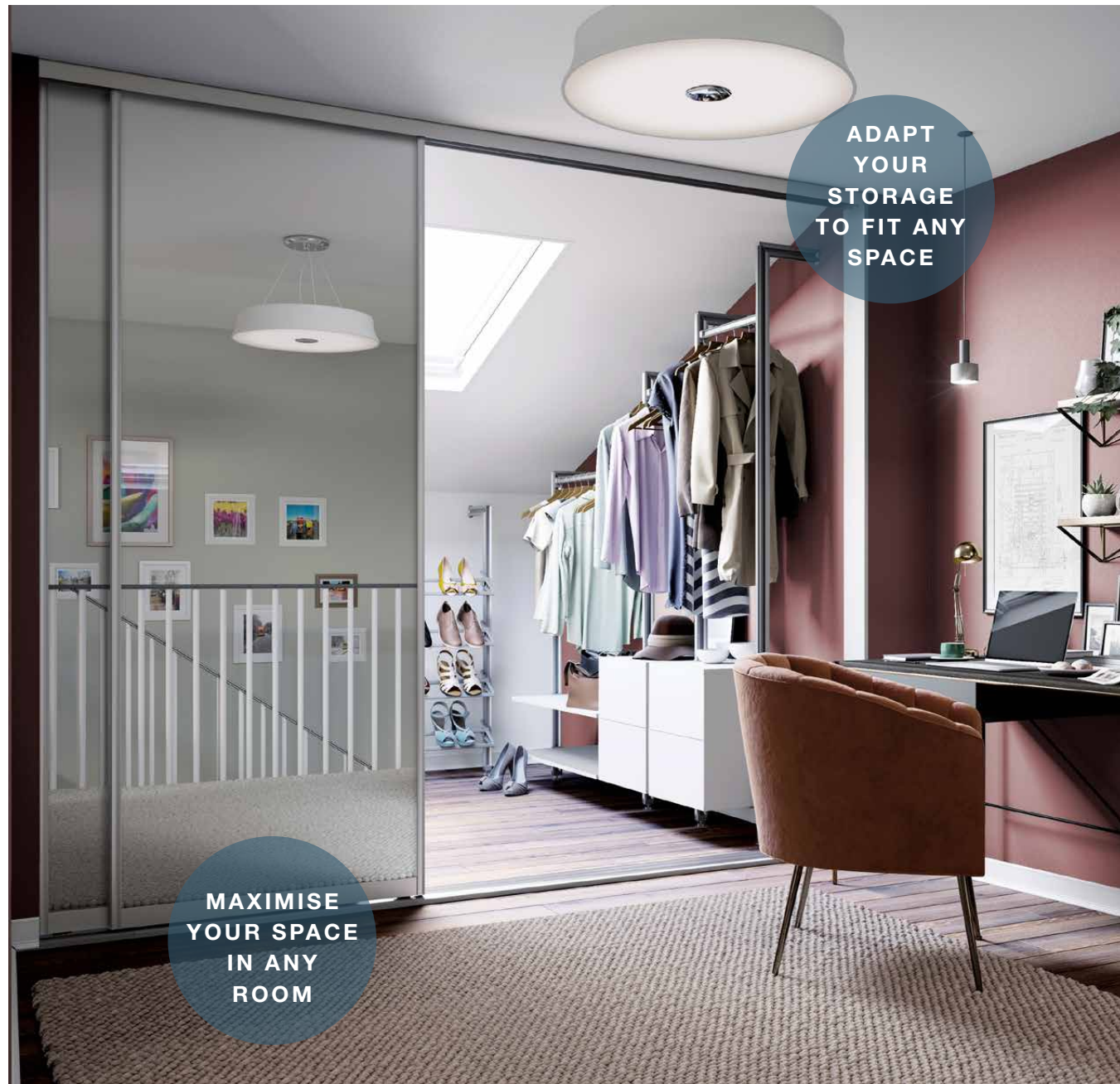

WHY CHOOSE SLIDING DOORS & MODULAR STORAGE?

Designed around you and your room, our sliding doors and storage systems not only ensure you get the maximum use out of your space, but come with a huge range of designs and finishes so that you can achieve a look that is truly personal to you.

THE PERFECT FIT

Sliding doors that fit any space from 1.15 - 2.48m high and 1.15 - 4.55m wide with a selection of fixed and custom sized doors, plus accessories to fit them.

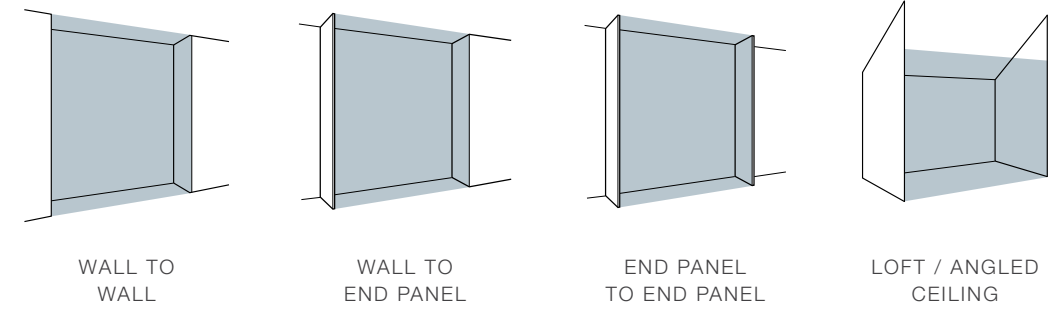

ADAPT YOUR STORAGE

Add, swap and adapt your storage as many times as you desire to suit your lifestyle and needs.



PERSONALISE

Personalise your doors with endless configurations and colours to choose from.

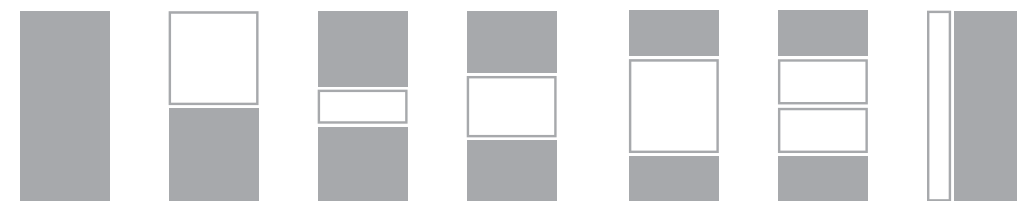

MAXIMISE YOUR SPACE

Save up to 500mm of floor space in front of your sliding wardrobes. With sliding doors, you don't need to allow any space in front of the wardrobe that you typically would for a hinged wardrobe.

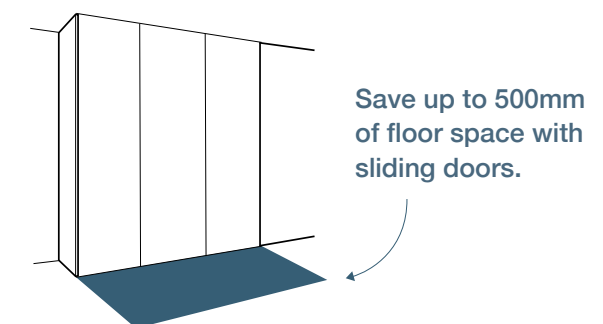



CREATE THIS
LOOK USING
END PANELS

page
49

Shown here: Classic 2x Single Panel Dark Blue Glass doors and 1 Single Panel Mirror door with a Graphite frame and Grey Textile Alutec interior.

GET THE LOOK

modular storage that can
change whenever you need

FOR ALL
INTERIOR
OPTIONS
see page
38

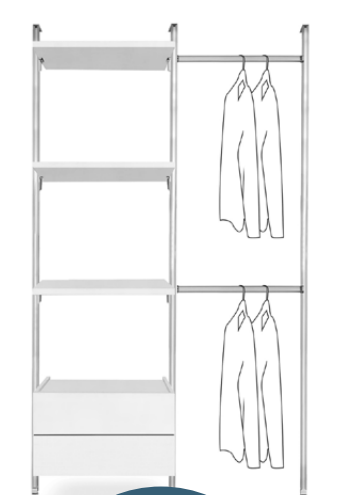

complement your room
with our range of door
designs & finishes

FOR ALL
FURNITURE
OPTIONS
see page
46



complement with
matching furniture



create a colour palette that looks
amazing with this wardrobe choice



TRANSFORM YOUR SPACE

With any hinged wardrobe, a lot of space is wasted in front, on the sides and above the actual wardrobe. Our floor to ceiling designs and modular interior solutions allow you to make use of every inch of space... without any unsightly clutter!



LOUNGE

Storage systems that are not only stylish but functional too. Turn unused areas into a handy office space!



LOFT

Reclaim the space lost to pitched roofs. Make any loft space just as stunning (and functional) as the rest of your home.



HALLWAY

Use our sliding doors to cover all of your hallway clutter.



OFFICE

With our Relax storage system, you can make even the most awkward spaces usable.



BEDROOM

Bring that touch of luxury into your bedroom. Why not create your own walk-in wardrobe?

KITCHEN / UTILITY

Our storage systems can be used anywhere around the home to help you organise your home.

SOLUTIONS FOR EVERY ROOM

Get creative – our doors and storage systems are not only for the bedroom! Hide away boots and coats in the hallway, turn awkward spaces into a home office, transform the eaves in your attic into useful storage or even add a bit of luxury with your very own walk in wardrobe!

*Furniture images are for representation only.



Shown here: 3x Single Panel doors. White glass with a White frame & Standard Storage interior.



CREATE THIS LOOK USING END PANELS

page 49

CREATE THIS LOOK WITH OUR COMPLIMENTING FURNITURE

page 46

Shown here: 3x Single Panel doors. Oak & Mirror with an Oak frame.

MULTIPLE FINISHES TO CHOOSE FROM, WITH ENDLESS DESIGNS TO MAKE IT YOUR OWN.

HERITAGE

A slim, curved frame with an easy to grip profile.





Shown here: 4x Single Panel doors. Grey Mirror with a White frame and Alutec Interior

CUSTOM DOORS CAN BE MADE AS SMALL AS 1.15M HIGH - PERFECT FOR LOFT SPACES!

HERITAGE

DOOR FINISHES

WOOD EFFECT & PANEL

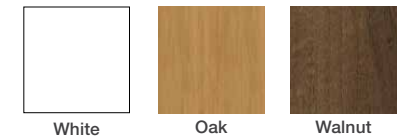

GLASS & MIRROR



FRAME FINISHES

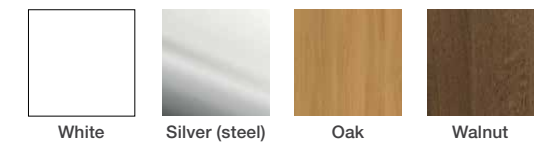

* All finishes are available to custom sized doors. These finishes are not available to fixed sized doors.

WHAT SPACE DO I NEED?

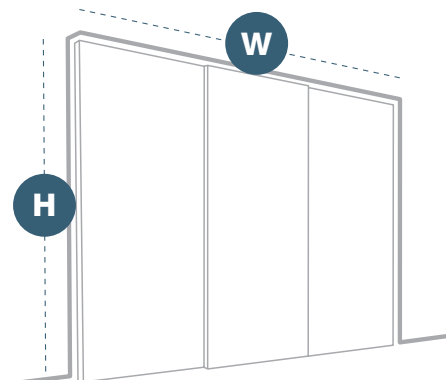

FIXED SIZED DOORS

H 2.26m
(opening height)

W 1.2 - 3.6m
(opening width)
3 set door widths available:
610mm, 762mm & 914mm

With these doors use trackset A. All fixed size tracksets come in 3 lengths. See page 49 for full details.

CUSTOM SIZED DOORS

H 1.15 - 2.48m
(opening height)

W 1.15 - 4.55m
(opening width)

SOFT CLOSE
fitted as standard

Custom doors come complete with colour matched trackset (matched to door frame).

DOOR DESIGN



Single Panel



Shown here: 3x Finline doors. Cashmere & Dark Grey glass with a Silver frame and Alutec interior.



Shown here: 4x Single Panel doors Mirror with a Nickel frame and Alutec interior.

MULTIPLE FINISHES TO CHOOSE FROM, WITH ENDLESS DESIGNS TO MAKE IT YOUR OWN.

CLASSIC

A traditional frame design, featuring a curved profile for easy handling.



CREATE THIS
LOOK USING
END PANELS

page
49



Shown here: 3x 4 Panel doors. Mirror & Dark Blue glass with a Graphite frame and Alutec interior. Top right: 3x Wideline doors. Stone Grey & Mirror with a Stone Grey frame.

CLASSIC

DOOR FINISHES

WOOD EFFECT & PANEL

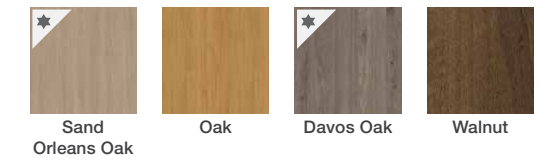
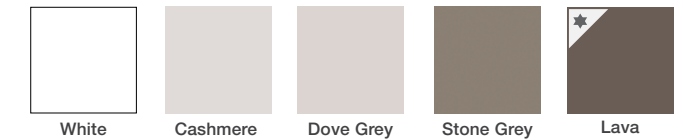

GLASS & MIRROR

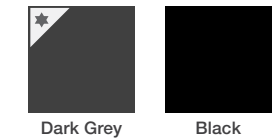
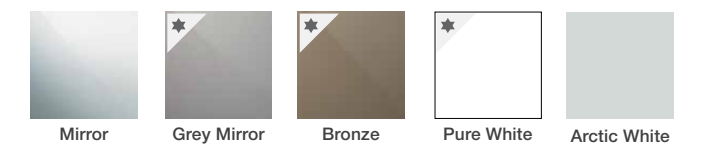

FRAME FINISHES

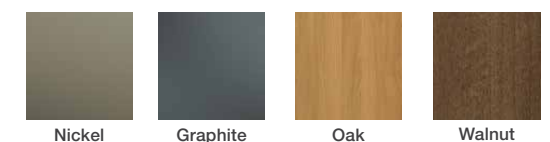
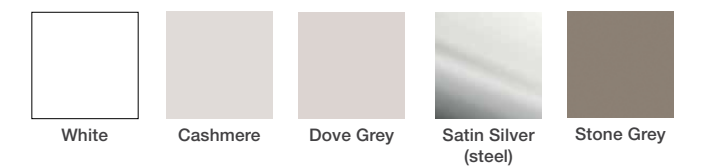

* All finishes are available to custom sized doors. These finishes are not available to fixed sized doors.

WHAT SPACE DO I NEED?

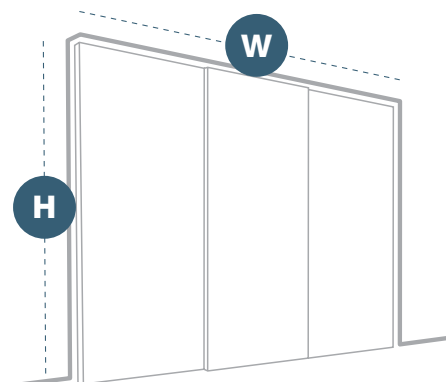

FIXED SIZED DOORS

H 2.26m
(opening height)

W 1.2 - 3.6m
(opening width)
3 set door widths available:
610mm, 762mm & 914mm

With these doors use trackset A. All fixed size tracksets come in 3 lengths. See page 49 for full details.

CUSTOM SIZED DOORS

H 1.15 - 2.48m
(opening height)

W 1.15 - 4.55m
(opening width)

SOFT CLOSE
fitted as standard

Custom doors come complete with colour matched trackset (matched to door frame).

DOOR DESIGN

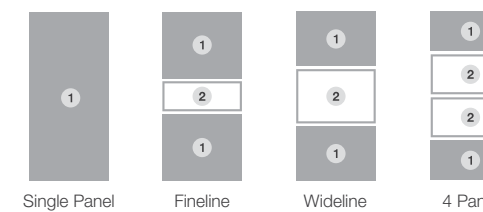

- 1 Top and bottom panels are the same finish.
- 2 Middle panels can be different to top and bottom.



Shown here: 3x Wideline doors. Cappuccino glass and Mirror with a Stone Grey frame.



CREATE THIS
LOOK USING
END PANELS

page
49

MULTIPLE
FINISHES TO
CHOOSE FROM, WITH
ENDLESS DESIGNS
TO MAKE IT YOUR
OWN.

Shown here: 3x Single Panel doors.
Mirror & with a Dove Grey frame and Alutec interior.

SHAKER

A bold,
contemporary
frame to create a
focal point in any
room.





Shown here: 4x Single Panel doors. Grey Mirror with a Graphite frame and Alutec interior.

SHAKER

DOOR FINISHES

WOOD EFFECT & PANEL

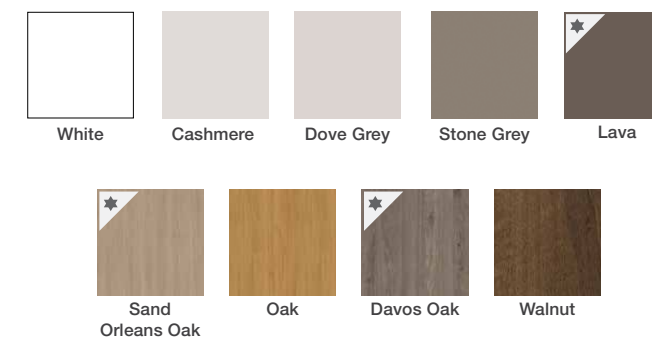

GLASS & MIRROR

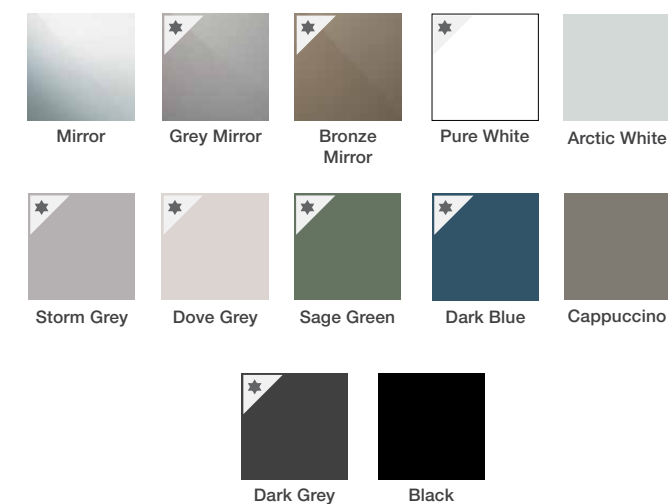

FRAME FINISHES



* All finishes are available to custom sized doors. These finishes are not available to fixed sized doors.

WHAT SPACE DO I NEED?

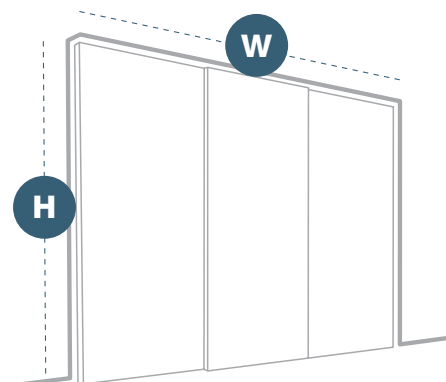

FIXED SIZED DOORS

H 2.26m
(opening height)

W 1.2 - 3.6m
(opening width)
3 set door widths available:
610mm, 762mm & 914mm

With these doors use trackset A. All fixed size tracksets come in 3 lengths. See page 49 for full details.

CUSTOM SIZED DOORS

H 1.15 - 2.48m
(opening height)

W 1.15 - 4.55m
(opening width)

SOFT CLOSE
fitted as standard

Custom doors come complete with colour matched trackset (matched to door frame).

DOOR DESIGN

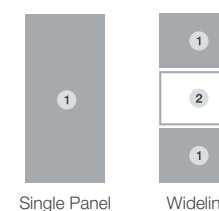

- 1 Top and bottom panels are the same finish.
- 2 Middle panels can be different to top and bottom.



Shown here: 2x 2 Panel Vertical doors and 2x Single Panel doors. Grey Mirror & Sand Orleans Oak.



MULTIPLE FINISHES TO CHOOSE FROM, WITH ENDLESS DESIGNS TO MAKE IT YOUR OWN.

Shown here: 3x Fineline doors. Davos Oak & Grey Mirror and Relax interior.

MIRAGE

A strong aluminium frame to add a contemporary update to your home.



CREATE THIS LOOK USING END PANELS

page 49



Shown here: 4x 4 Panel doors. Mirror & Sage Green glass and Standard Storage interior.
Top right: 3x Single Panel Bronze Mirror doors. Bottom right: 3x Extra Wideline Dark Blue glass and Mirror.

MIRAGE

DOOR FINISHES

WOOD EFFECT & PANEL



GLASS & MIRROR

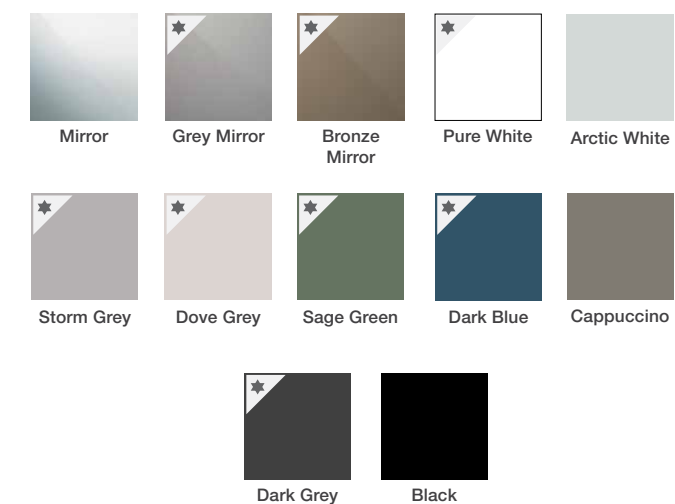

FRAME FINISHES



Satin Silver (aluminium)

* All finishes are available to custom sized doors. These finishes are not available to fixed sized doors.

WHAT SPACE DO I NEED?

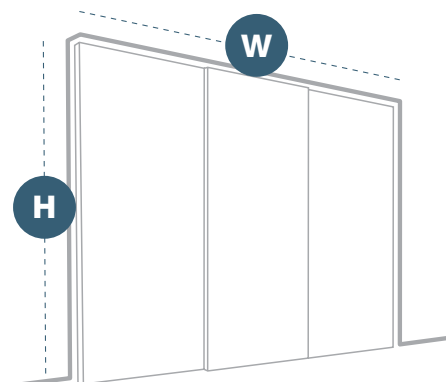

FIXED SIZED DOORS

H 2.26m
(opening height)

W 1.2 - 3.6m
(opening width)
3 set door widths available:
610mm, 762mm & 914mm

With these doors use trackset A. All fixed size tracksets come in 3 lengths. See page 49 for full details.

CUSTOM SIZED DOORS

H 1.15 - 2.48m
(opening height)

W 1.15 - 4.55m
(opening width)

SOFT CLOSE
fitted as standard

Custom doors come complete with colour matched trackset (matched to door frame).

DOOR DESIGN

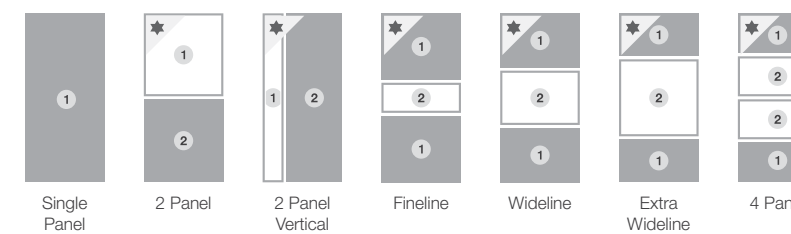

1 Top and bottom panels are the same finish.
2 Middle panels can be different to top and bottom.

CREATE THIS
LOOK USING
END PANELS

page
49



Shown here: 3x Extra Wideline doors: Black glass & Mirror and Alutec interior.

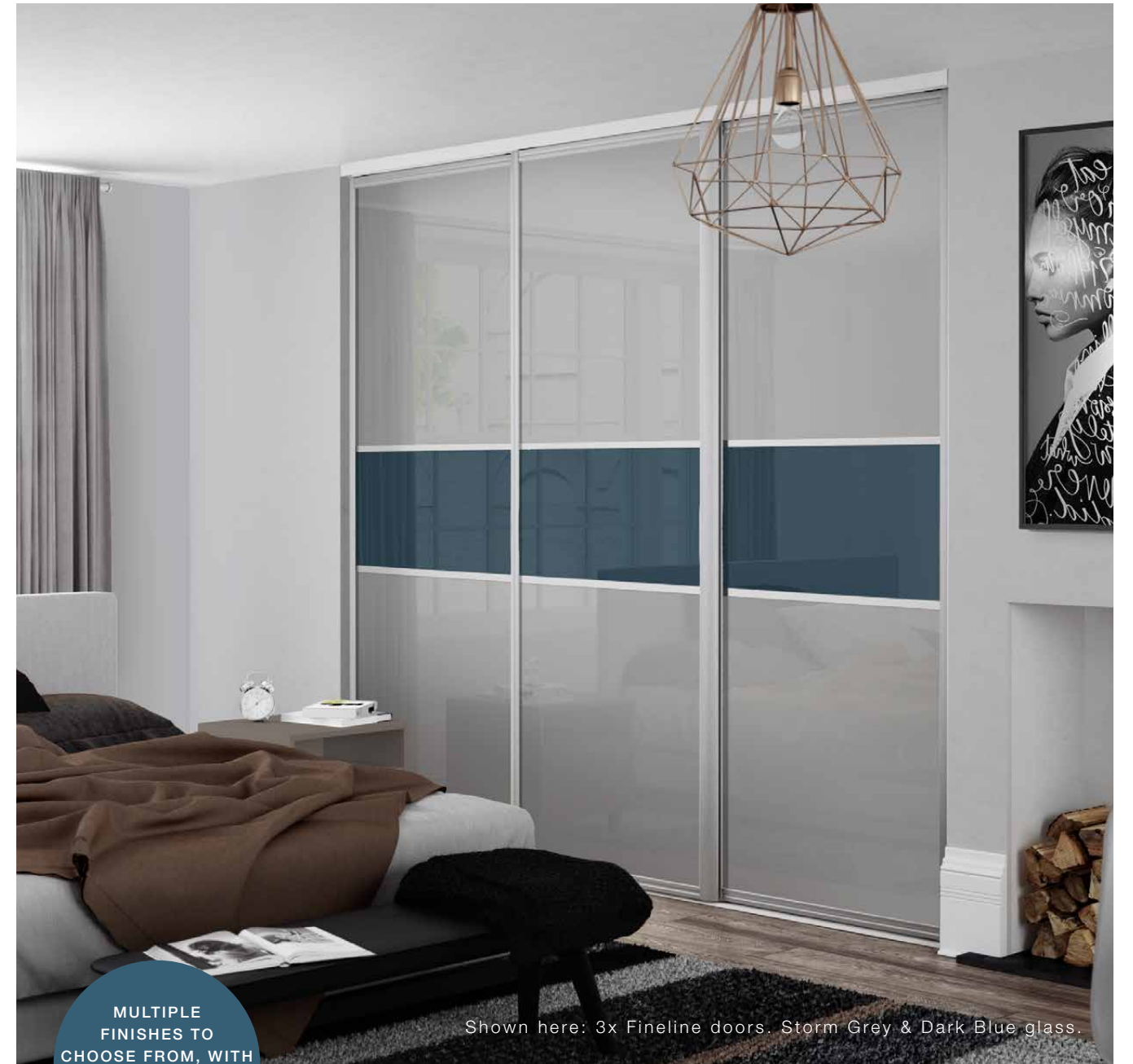

MULTIPLE
FINISHES TO
CHOOSE FROM, WITH
ENDLESS DESIGNS
TO MAKE IT YOUR
OWN.

Shown here: 3x Fineline doors: Storm Grey & Dark Blue glass.

GLAM

A bold, curved frame
creating a statement
design.





Shown here: 4x Wideline with Davos Oak and Grey Mirror.

Top right: 3x Single Panel doors in White panel. Bottom right: 3x 4 Panel doors in Mirror.

GLAM

DOOR FINISHES

WOOD EFFECT & PANEL



GLASS & MIRROR

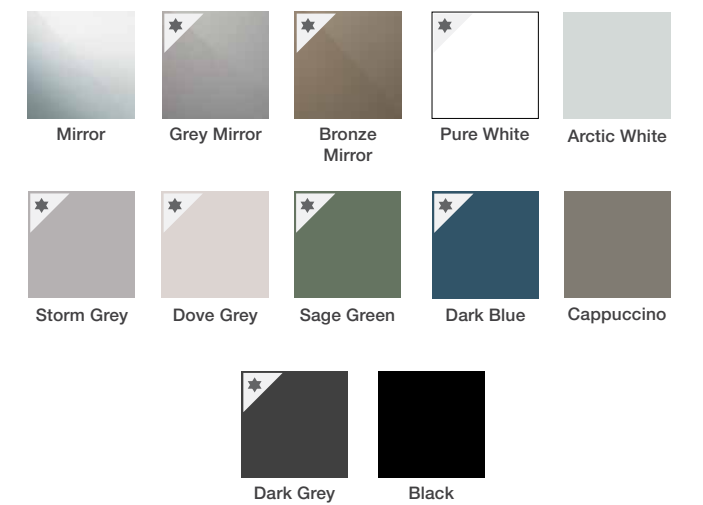

FRAME FINISHES

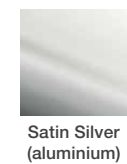

* All finishes are available to custom sized doors. These finishes are not available to fixed sized doors.

WHAT SPACE DO I NEED?

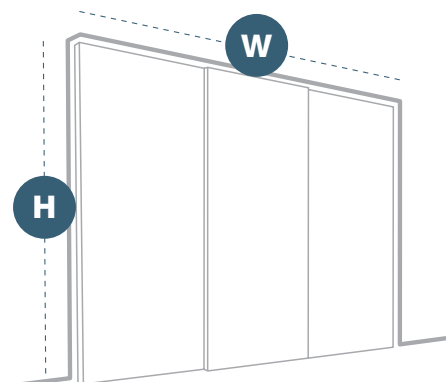

FIXED SIZED DOORS

H 2.26m
(opening height)

W 1.2 - 3.6m
(opening width)
3 set door widths available:
610mm, 762mm & 914mm

With these doors use trackset A. All fixed size tracksets come in 3 lengths. See page 49 for full details.

CUSTOM SIZED DOORS

H 1.15 - 2.48m
(opening height)

W 1.15 - 4.55m
(opening width)

SOFT CLOSE
fitted as standard

Custom doors come complete with colour matched trackset (matched to door frame).

DOOR DESIGN

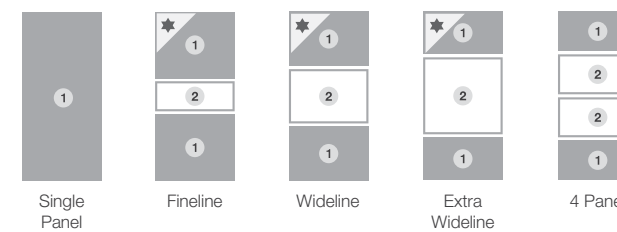

* exclusive to custom sized doors

- 1 Top and bottom panels are the same finish.
- 2 Middle panels can be different to top and bottom.



Shown here: 4x 2 Panel doors. Dark Grey glass with a Silver frame and Alutec interior.



MULTIPLE FINISHES TO CHOOSE FROM, WITH ENDLESS DESIGNS TO MAKE IT YOUR OWN.

Shown here: 4x 2 Panel doors. Storm Grey glass with a Matt Black frame and Standard Storage interior.

REFLEX

Our slimmest frame design with a central handle for effortless opening.





Shown here: 4x 2 Panel doors. Dark Blue glass with a Silver frame.

CREATE THIS
LOOK WITH OUR
COMPLIMENTING
FURNITURE
page
46

REFLEX

DOOR FINISHES

GLASS & MIRROR



FRAME FINISHES



* All finishes are available to custom sized doors.
These finishes are not available to fixed sized doors.

WHAT SPACE DO I NEED?

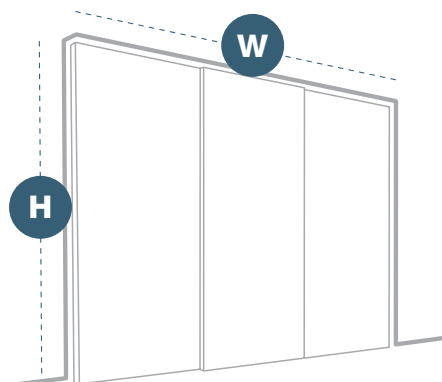

FIXED SIZED DOORS

H 2.26m
(opening height)

W 1.2 - 3.6m
(opening width)
3 set door widths available:
610mm, 762mm & 914mm

With these doors use
trackset A. All fixed size
tracksets come in 3 lengths.
See page 49 for full details.

CUSTOM SIZED DOORS

H 1.15 - 2.48m
(opening height)

W 1.15 - 4.55m
(opening width)

SOFT CLOSE
fitted as standard

Custom doors come
complete with **colour
matched trackset**
(matched to door frame).

DOOR DESIGN



2 Panel

- 1 Top and bottom panels are the same finish.
- 2 Middle panels can be different to top and bottom.

CREATE THIS
LOOK USING
END PANELS

page
49



Shown here: 4x Finline doors: Mirror & Black glass and Relax interior.

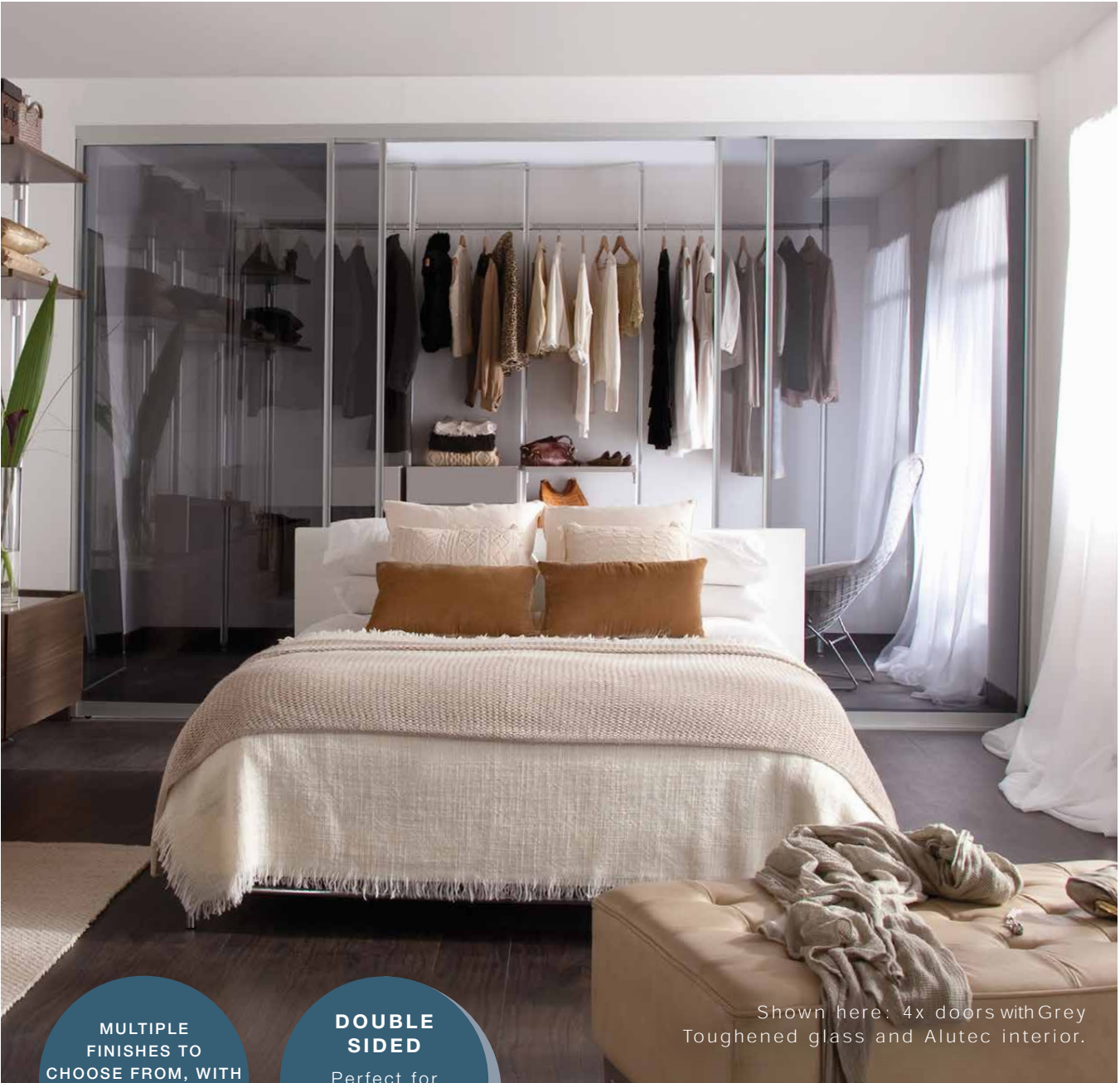

Shown here: 4x doors with Grey Toughened glass and Alutec interior.

MULTIPLE FINISHES TO CHOOSE FROM, WITH ENDLESS DESIGNS TO MAKE IT YOUR OWN.

DOUBLE SIDED
Perfect for creating a walk in wardrobe or room divider.

SWITCH

A slim curved door frame which can be used for your wardrobe, but also as a room divider.





DOUBLE SIDED
Perfect for creating a walk in wardrobe or room divider.

CREATE THIS LOOK WITH OUR COMPLIMENTING FURNITURE
page 46

Shown here: 2x Single Panel doors, Mirror/Silver frame and Alutec interior - To p r i g h t: 2x Wideline doors, Sage Green glass/Silver frame & Alutec interior

SWITCH

DOOR FINISHES

GLASS & MIRROR

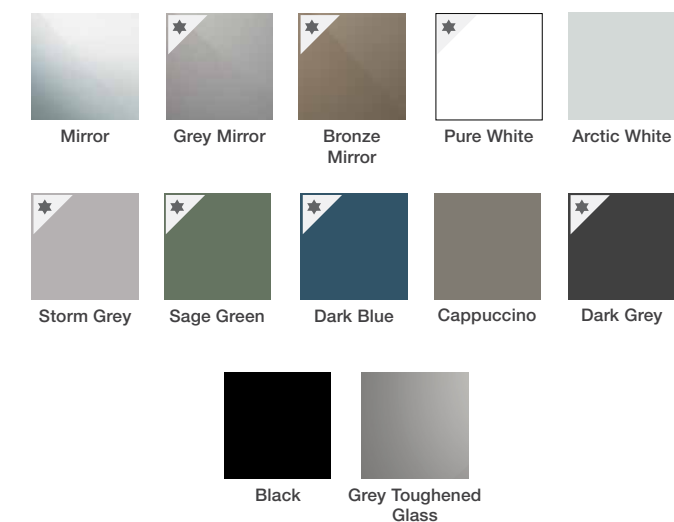

FRAME FINISHES

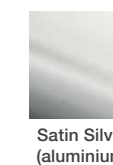

* All finishes are available to custom sized doors. These finishes are not available to fixed sized doors.

WHAT SPACE DO I NEED?

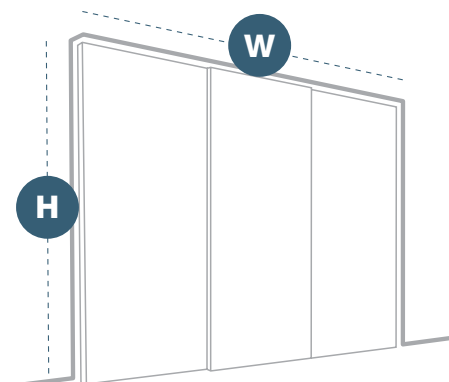

FIXED SIZED DOORS

H 2.26m
(opening height)

W 1.2 - 3.6m
(opening width)
3 set door widths available:
610mm, 762mm & 914mm

With these doors use trackset A. All fixed size tracksets come in 3 lengths. See page 49 for full details.

CUSTOM SIZED DOORS

H 1.15 - 2.48m
(opening height)

W 1.15 - 4.55m
(opening width)

SOFT CLOSE
fitted as standard

Custom doors come complete with colour matched trackset (matched to door frame).

DOOR DESIGN

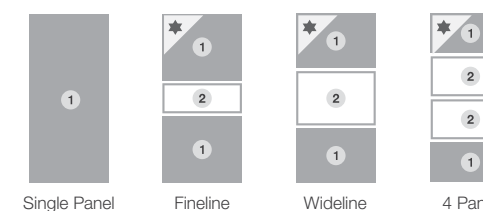

* exclusive to custom sized doors

- 1 Top and bottom panels are the same finish.
- 2 Middle panels can be different to top and bottom.

Both sides of the Switch door are the same design.

UNDER STAIRS

Transform unused areas to create extra storage and work space



Shown here: Relay interior in Gray Textile

HOME OFFICE

Create stunning work spaces with our modular storage systems, that can be adapted and changed at any time to suit your needs.



LOFT

Our stanchions can be trimmed to any size to fit even the most smallest of spaces.



WALK-IN WARDROBE

Whether it's a small wardrobe or walk-in closet, our storage systems can be built for any space.



WARDROBE INTERIOR

Our storage systems work well both behind sliding doors or as a stylish stand alone piece of furniture.

TRANSFORM YOUR STORAGE

Wasted space can be a thing of the past when using our modular storage systems to maximise unused areas around the home. With a range of different storage systems to choose from and a choice of complementary finishes, our selection of furniture will work inside the wardrobe or on full display.



Shown here: Aura interior in White

AURA

The Aura storage system runs floor to ceiling and can adapt with any lifestyle. Reorganise your storage, add accessories, shoe racks or additional shelving whenever you need.

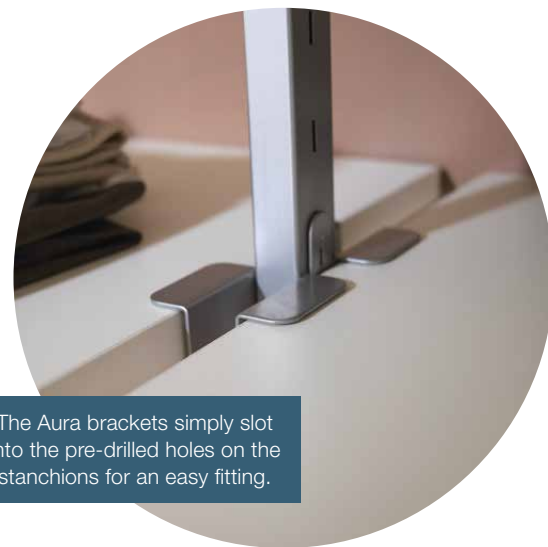

The Aura brackets simply slot into the pre-drilled holes on the stanchions for an easy fitting.

STORAGE CONFIGURATIONS

The modular accessories can be easily moved around to suit any room. Small, medium or large bedrooms, our modular storage systems adapt around you.

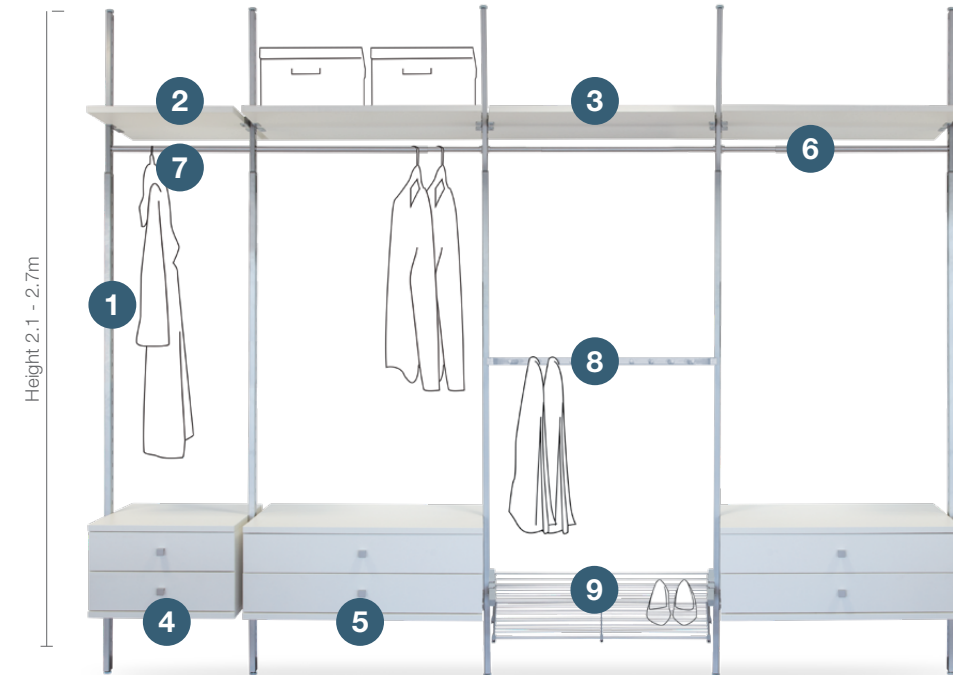
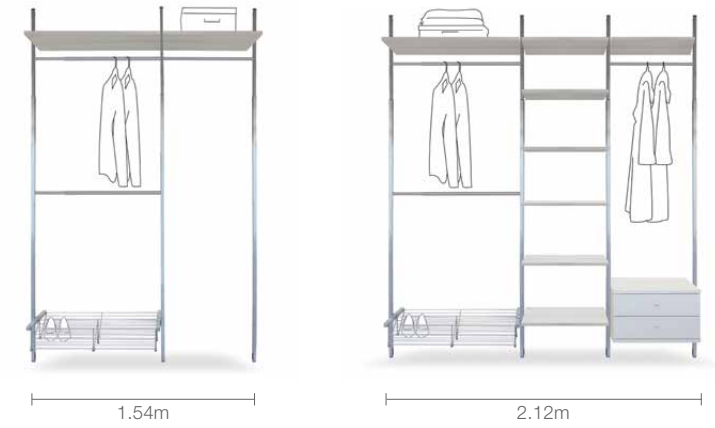

1 TELESCOPIC POST
Silver effect
H 2110 – 2700mm
2632-000-SC

2 SMALL SINGLE SHELF
H 25 x W 550 x D 500mm
2687-550-WT White
2687-550-OK Oak effect

3 LARGE SINGLE SHELF
H 25 x W 900 x D 500mm
2687-900-WT White
2687-900-OK Oak effect

4 SMALL TWO DRAWER KIT
H 350 x W 550 x D 500mm
2686-550-WT White
2686-550-OK Oak effect

5 LARGE TWO DRAWER KIT
H 350 x W 900 x D 500mm
2685-900-WT White
2685-900-OK Oak effect

6 TELESCOPIC HANGER BAR RAIL
Silver effect
W 720 – 1300mm
2629-SC

7 FIXED HANGER BAR RAIL
Silver effect
W 550mm
2969-550-SC

8 TROUSER RACK
Silver effect
H 25 x W 900 x D 500mm
2681-SC

9 DOUBLE SHOE RACK
Silver effect
W 900mm
2694-SC

ADDITIONAL COMPONENTS

DRAWER BRACKETS
Silver effect. Pack of 2
2698-SC



SHELF BRACKETS
Silver effect. Pack of 2
2572-SC



SHELF & DRAWER FINISHES

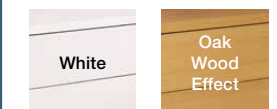

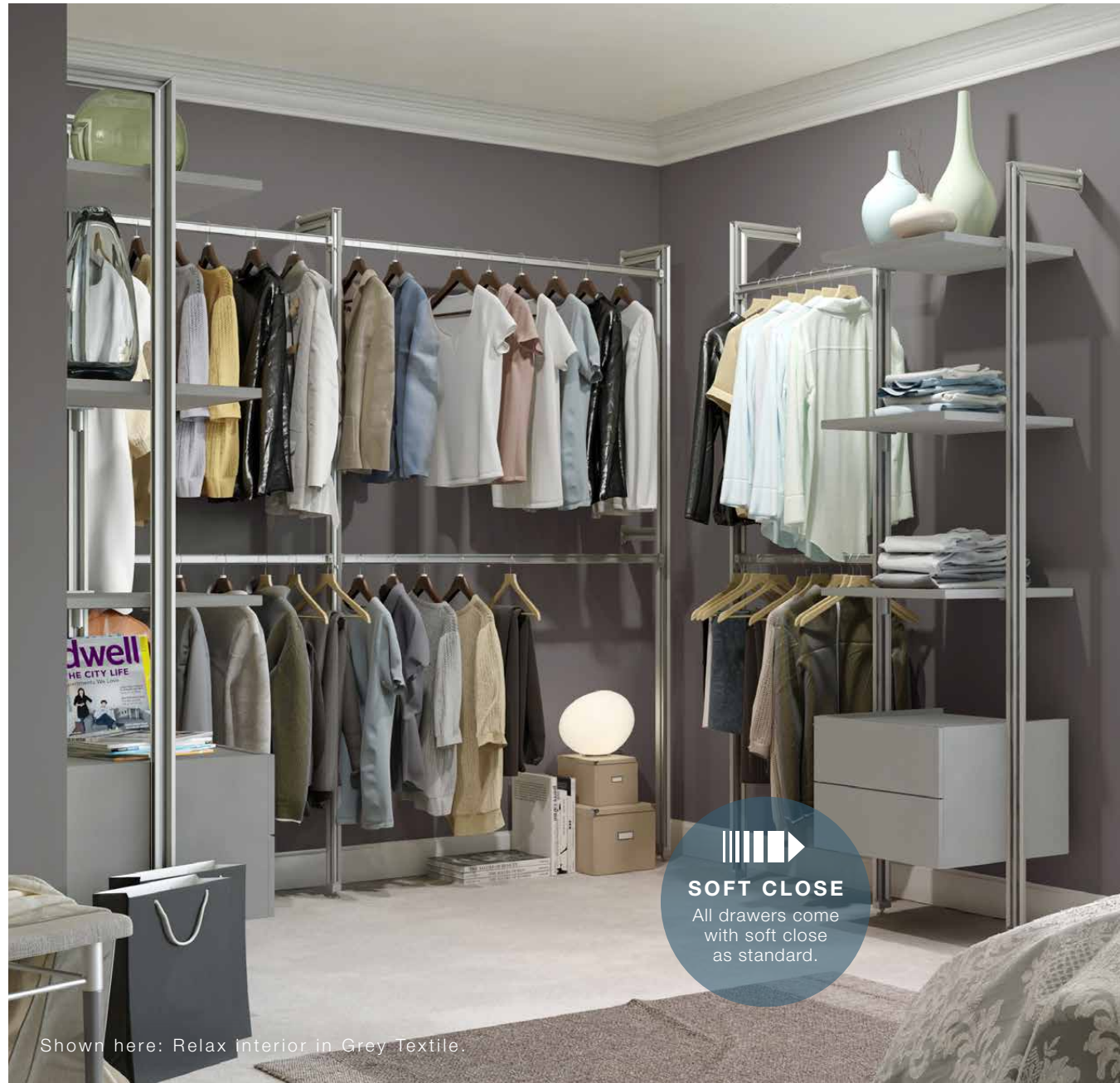

Shown here: Relax Interior in Grey Textile.

ALUTEC

This modular storage system can run from floor to ceiling or floor to wall depending on your space and needs. Reorganise your storage, add accessories, shoe racks or additional shelving as often as you like.



The Alutec clamp brackets allow any component to sit at any position on the stanchions.

STORAGE CONFIGURATIONS

The modular accessories can be easily moved around to suit any room. Small, medium or large bedrooms, our modular storage systems adapt around you.

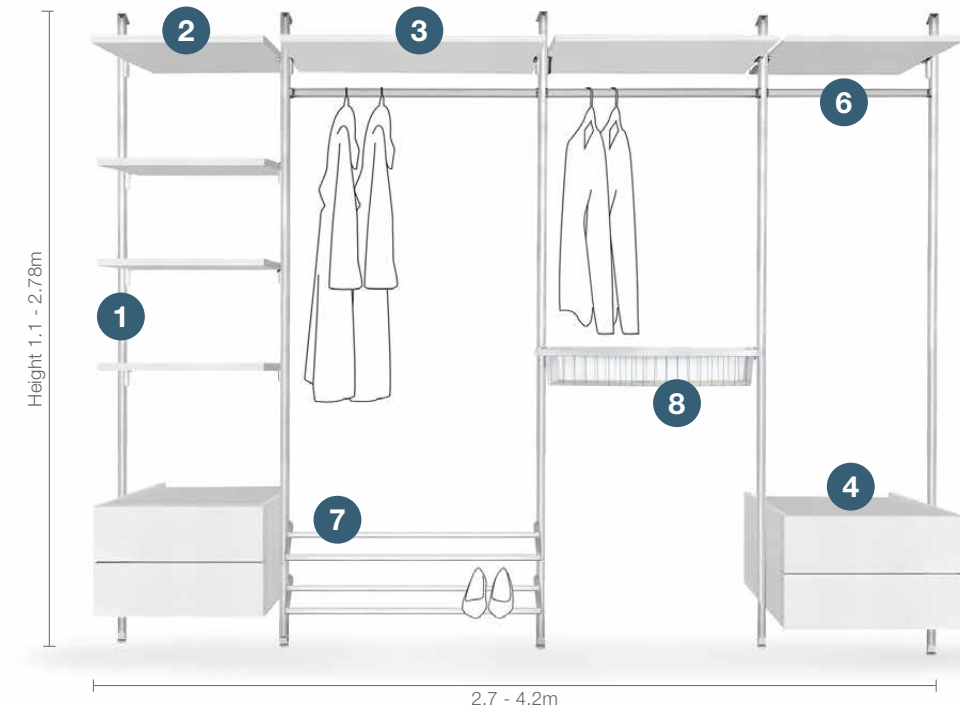
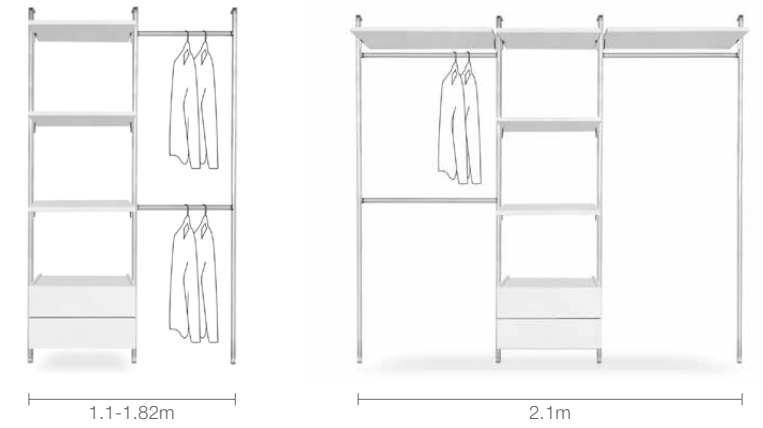

- 1 FLOOR TO CEILING STANCHION**
H 2780mm – can be cut to size
SSR-2020-106-AN

- FLOOR TO WALL STANCHION**
H 2280mm – can be cut to size
SSR-2121-080-AN

- 2 SMALL DEEP SHELF**
H 25 x W 550 x D 500mm
SSR-3090-5550-GT Grey Textile
SSR-3090-5550-PW White

- SMALL NARROW SHELF**
H 25 x W 550 x D 330mm
SSR-3090-5533-GT Grey Textile
SSR-3090-5533-PW White

- 3 LARGE DEEP SHELF**
H 25 x W 900 x D 500mm
SSR-3090-9050-GT Grey Textile
SSR-3090-9050-PW White

- LARGE NARROW SHELF**
H 25 x W 900 x D 330mm
SSR-3090-9033-GT Grey Textile
SSR-3090-9033-PW White

- EXTRA LARGE SHELF KIT**
H 25 x W 1220 x D 500mm
SSR-3090-1250-GT Grey Textile
SSR-3090-1250-PW White

- 4 SMALL DOUBLE DRAWER**
H 380 x W 550 x D 500mm
SSR-2946-550-GT Grey Textile
SSR-2946-550-PW White

- 5 LARGE DOUBLE DRAWER**
H 380 x W 900 x D 500mm
SSR-2945-900-GT Grey Textile
SSR-2945-900-PW White

- 6 HANGER BAR**
W 1220mm – can be cut to size
SSR-2022-048-AN

- 7 SHOE RACK**
W 1220mm – can be cut to size
SSR-2123-048-AN

- 8 SLIDING BASKET**
W 900mm
SSR-2454-900-AN

ADDITIONAL COMPONENTS

- MINI WALL STANCHION**
Allow you to fix your items to the wall.
SSR-2305-006-AN

- ADDITIONAL STANCHION SUPPORT**
Adds extra strength to your stanchions, particularly helpful for pull out components.
SSR-8622-222-AN

- SHELF EDGE KIT** Pack of 2
If you have to cut down your shelf, use these shelf edges to hide the cut sides.
SSR-3525-AN

SHELF & DRAWER FINISHES





Shown here: Standard Storage System in Dove Grey.
Top right: Shelf and End Panel in Oak.

FINISHES



STANDARD STORAGE SYSTEMS

Our range of standard storage units can be arranged to perfectly match your choice of sliding doors.



SHELF & HANGER
This storage unit fits a maximum width of 2500mm and is 500mm deep.

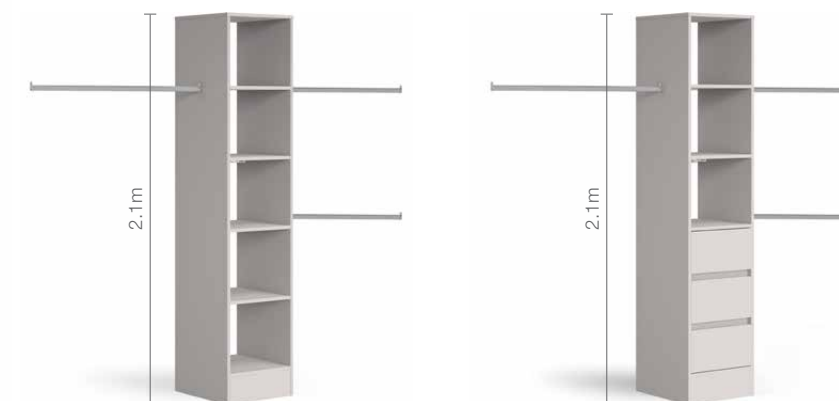

TOWER UNITS
Available in two widths of 450mm and 600mm with a choice of a 3 drawer combination or shelves only. All drawers come with soft close as standard. Maximum opening width 2800mm x Tower Unit height 2100mm x Depth 500mm.

SOFT CLOSE
 All drawers come with soft close as standard.



FINISHES

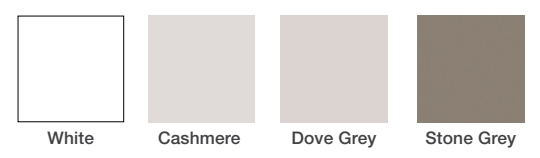

Shown here: Chest of Drawers in Cashmere.
 Top right: Bedside drawers in White. Bottom right: Tallboy in Stone Grey.

FREESTANDING FURNITURE

Complement your sliding wardrobes and storage systems with our range of bedroom furniture.



BEDSIDE UNIT
 W450 x H515 x D500mm



CHEST OF DRAWERS
 W1000 x H800 x D500mm



TALLBOY
 W600 x H1150 x D500mm



BUILD DOWN
Use Liners to build down when using our fixed sized doors.

BUILD TO AN END PANEL
Create your ideal space using end panels.

Shown here: Heritage 2x Single Panel Mirror doors with a White frame

CREATE YOUR WARDROBE OPENING

Create the look you want no matter what space you have. In addition to wall to wall installations, our sliding wardrobes can also be installed using our matching end panels and accessories - fitting any space.

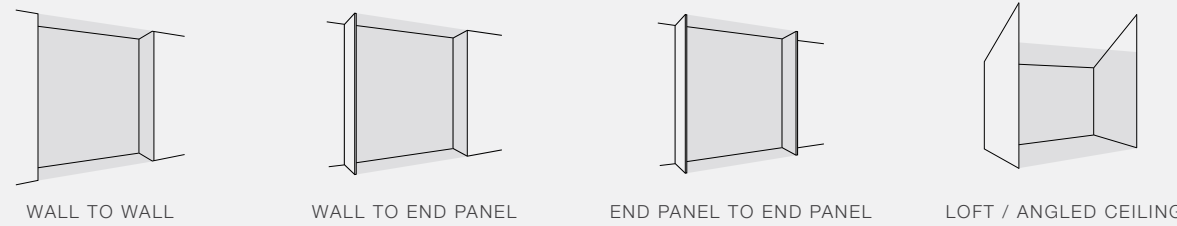

FITTING ACCESSORIES

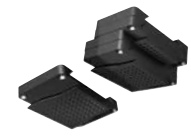

SPACER BLOCKS
Pack of 12
Reduces gaps by up to 120mm
4320X-SP



OPENING HEIGHT REDUCER
Pack of 1
Reduces gaps between 127-457mm
4300X-SP



FIXING BLOCKS
Pack of 10
Fits end panels to existing walls
4829-SP



ANGLED CEILING BRACKET
Pack of 2
Used for sloping ceilings
4310-SP

END PANELS & LINERS

END PANEL:
L2800mm x W620mm x D18mm

End panels are large sections of timber used to create an artificial wall for the doors to run up to. We supply these in various finishes to match your doors.

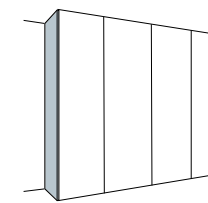

LINER:
L2800mm x H90mm x D18mm

Our Liners can be used alongside our fitting accessories if you need to reduce your height or if you need to frame your wardrobe doors (creating a square opening).

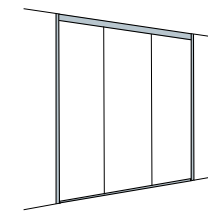

FINISHES



TRACKSETS

FIXED SIZED TRACKSETS:
Available in: 1803mm, 2692mm & 3606mm

With our fixed sized sliding doors, you will need to purchase the tracksets separately. Our Steel tracksets are now available in matching finishes to compliment your frame choice.

- Choose Trackset A (Colour Matched Steel)**
For Heritage, Classic & Shaker doors.
- Choose Trackset B (Aluminium to match frame)**
For Ellipse, Switch, Reflex & Mirage doors.

STEEL TRACKSET FINISHES



All our custom sized doors come complete with colour matched tracksets.



Shown here: Heritage 3x Single Panel doors. White glass with a Silver frame & Standard Storage interior.

PLANNING YOUR SLIDING DOORS

Now it's time to measure up and choose which doors would best suit your needs and space.

1 MEASURE UP

It's really important to prepare your project by measuring up your space, ensuring all doors fit correctly.

Why we need your measurements:

Height – No ceiling and floor are perfectly level, so to ensure our doors fit correctly we need 3 measurements A, B and C. Our doors are made to the smallest height to guarantee the doors slide effortlessly.

Width – Measure at the top and bottom of your space D and E.

Depth – Our interior systems require a minimum depth of 620mm.

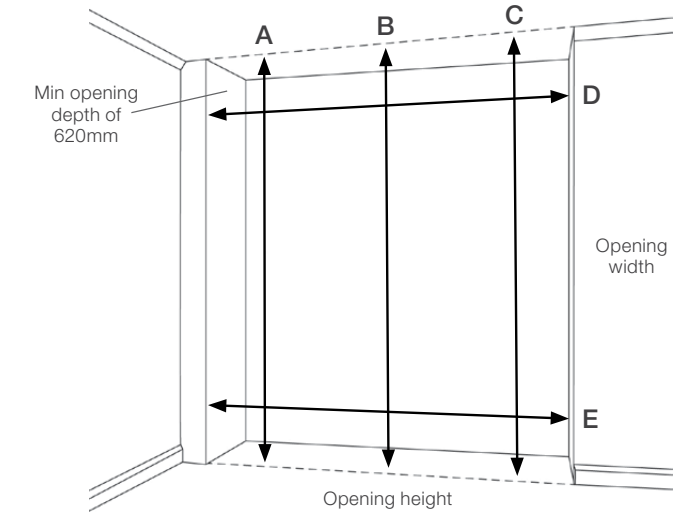

2 IDENTIFY YOUR SPACE

Once you know what space you have to work with, we have two door options to help you achieve your project. Using our fixed or custom sized doors you will be able to maximise your space and organise belongings with ease.

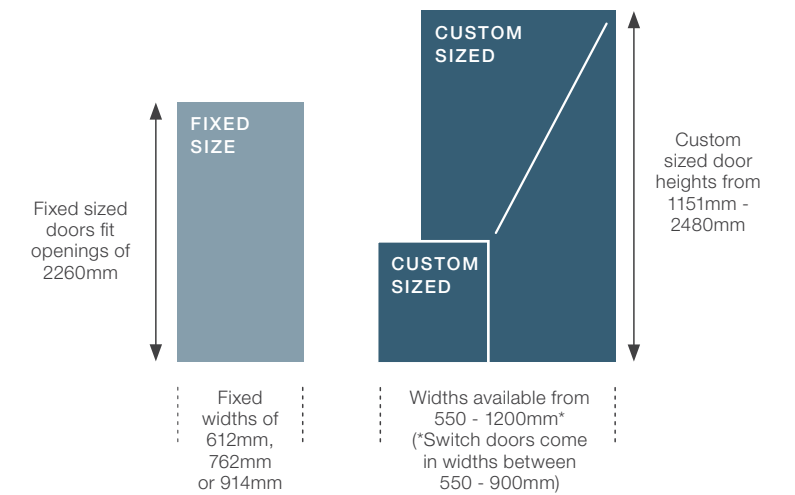

3 CHOOSE FIXED OR CUSTOM SIZED DOORS

	SIZES	FINISHES	SOFT-CLOSE INCLUDED	TRACKSET	FITTING ACCESSORIES	INSTALLATION TIME
FIXED SIZE DOORS	Available in 3 widths 610, 762 & 914mm. Fits height of 2260mm	Selection of finishes	N/A	Sold separately - will need to be cut to size. Silver and White only	If room height is over 2260mm then fitting accessories will be needed	Allow some additional time to cut track sets to size.
CUSTOM SIZED DOORS	Made to fit any opening	Full range of finishes	✓	Included and cut to your opening. Colour matched to frame	Made to fit your opening.	All items are made to fit, so each item can fit right in.

CALCULATE HOW MANY FIXED SIZED DOORS YOU NEED

When buying one of our fixed sized door options you will need to calculate how many doors you need to fit your opening as well as what width of door.

As each of our door frames is different, we have created a simple calculation table to do this.

See page 55 for each door frame dimension.

$$\text{Ideal opening width* for 2 doors} = (2 \times \text{Door width}) - (1 \times \text{Overlap})$$

$$\text{Ideal opening width* for 3 doors} = (3 \times \text{Door width}) - (2 \times \text{Overlaps})$$

$$\text{Ideal opening width* for 4 doors} = (4 \times \text{Door width}) - (2 \times \text{Overlaps})$$

Example: Classic 3 x Door opening (3 x 762mm wide doors = 2286mm) Deduct 70mm for 2 overlaps (Classic frame is 35mm wide) = **2216mm opening width.**



Shown here: Relax interior in Grey Textile.

PLANNING YOUR MODULAR STORAGE

Whether you're planning a standalone interior system or storage behind your sliding doors, use our guide to help you plan the best configuration for your space.

1 MEASURE UP

It's really important to prepare your project by measuring up your space. This will ensure the chosen storage system fits perfectly.

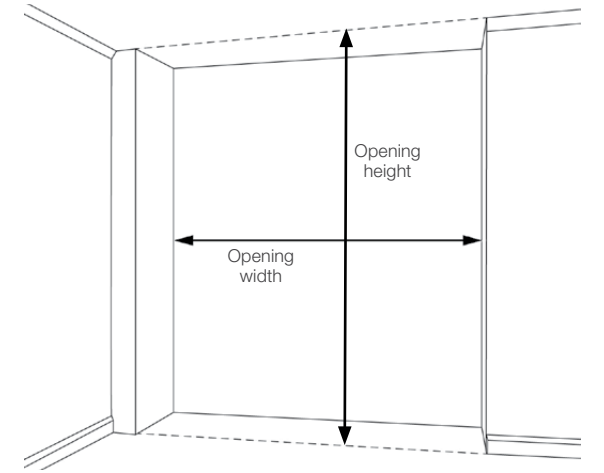

2 CHOOSE YOUR STORAGE SYSTEM

Now you have your measurements, you can start to plan your interior storage solution. Our stanchion based systems can run from floor to ceiling or floor to wall depending on your space and needs.

ALUTEC
Stanchion width **30mm**

For **550mm** accessories.
Width plus 2 stanchions
= **610mm**

For **900mm** accessories.
Width plus 2 stanchions
= **960mm**

AURA
Stanchion width **25mm**

For **550mm** accessories.
Width plus 2 stanchions
= **600mm**

For **900mm** accessories.
Width plus 2 stanchions
= **950mm**

3 PLAN YOUR MODULAR STORAGE

When planning your modular storage interior, start with the first column to the far side of your space, then add on additional columns until you have filled your space.

Most accessories are 550mm or 900mm wide, but we have adjustable components that can be cut to size to fill in that extra space.

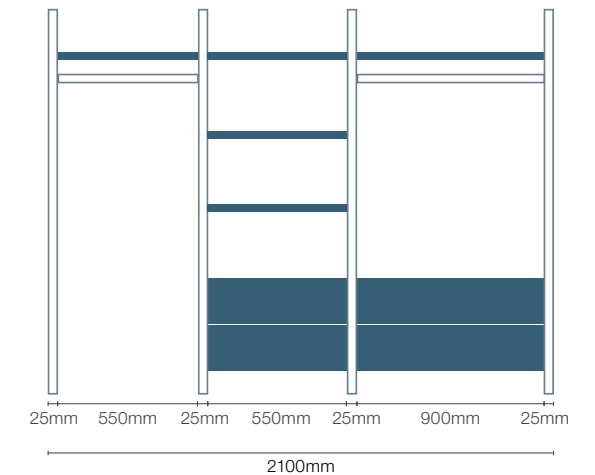

ACCESSORY PLACEMENT & ARRANGEMENT WITH DOORS

When using any pull out accessory (i.e. drawer units) we recommend making your doors at least 80mm wider than the storage column behind. This gives you plenty of breathing space for the drawers to open without clashing with where the doors cross over.

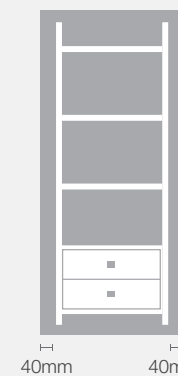

2 door opening
Position the drawer to the left or right hand side.

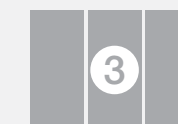

3 door opening
Position the drawers to the left or right hand side.

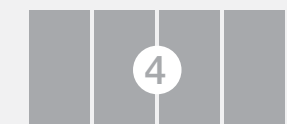

4 door opening
Position the drawers to the far left, middle or right hand side.



FRAME SIZES

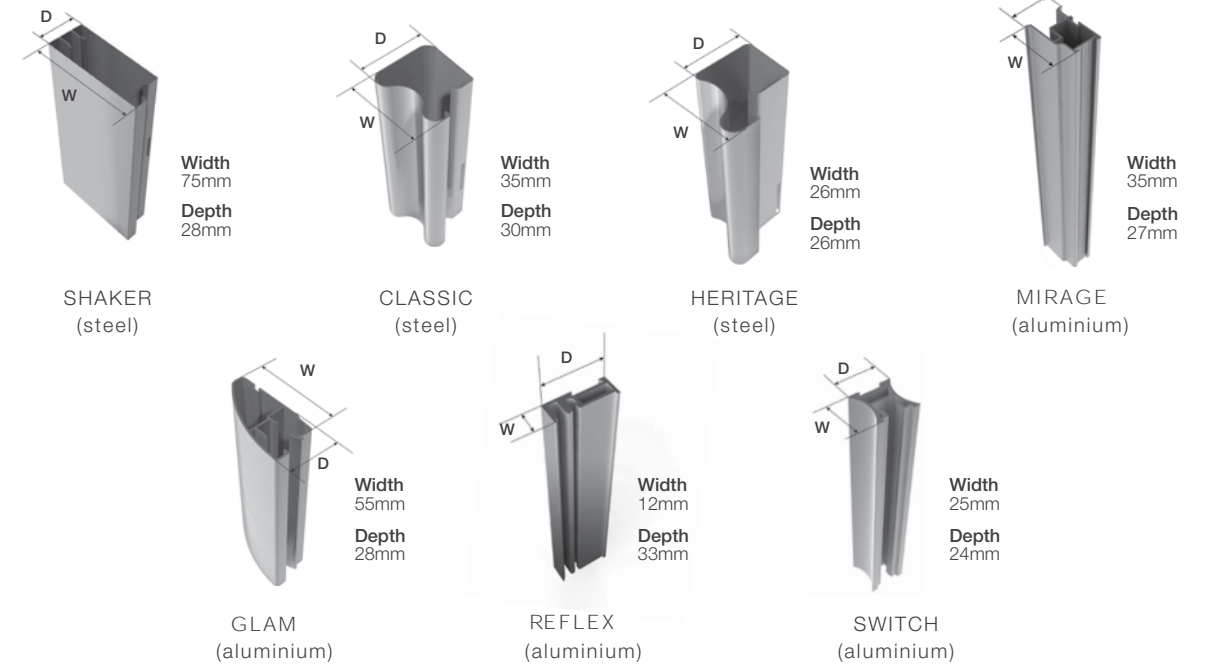

TYPES OF TRACK

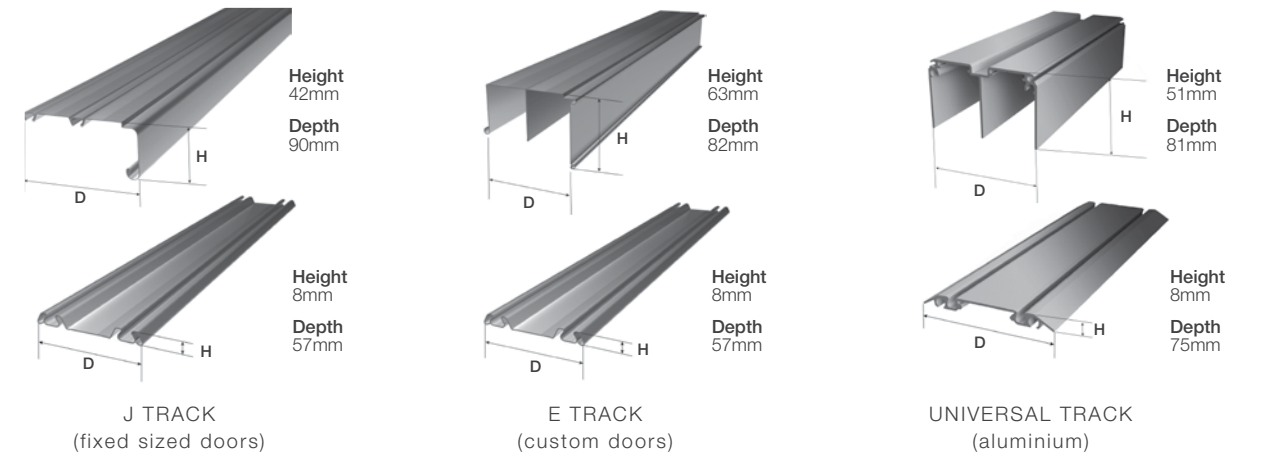

HOW OUR DOORS FIT

Our doors operate as a 'weight bearing' bottom rolling system with inclusive anti-jump.*
Guides inside the top track ensure the doors run smoothly.

*Anti-jump feature only on our steel doors. The aluminium doors feature our sprung loaded bottom guides.



PRODUCT SPECIFICATION

With different frames, styles and tracks available, take a closer look at how our sliding doors work and operate.

SLIDINGROBES DIRECT
SLIDING WARDROBES DELIVERED TO YOUR DOOR

Designed around you and your room, our sliding doors and storage systems ensure you get the maximum use out of every space.



MADE IN GREAT BRITAIN

SLIDINGROBESDIRECT.COM